

Temperature Sensors without Thread

Application

- temperature measurement in pipes with different diameters
- installation in thin-walled pipes and vessels
- without direct contact of the sensor to the product (with thermowell)
- remove the sensor without opening the process (with thermowell)

Application Examples

- process monitoring in a pipe bow
- temperature measurement in pressure pipes
- measuring of paste products in pipes

Hygienic Design / Process Connection

- hygienic measurement point which is easy to sterilize (EHEDG, 3A-certificates)
- because of elastomer free sealing system, the connection will be without gaps and crevices
- CIP-/ SIP-cleaning up to 140°C
- food compatible materials according to FDA
- sensor completely made of stainless steel
- adapters available for all current process connections

Features

- variable insertion depths
- available with or without integrated transmitter
- different kinds of electrical connections available

Option / Accessories

- 2xPt100
- transmitter mpu-4 for different ranges, output 4-20mA
- Pt100 chip with other classes of accuracy, e.g. 1/3 DIN B, 1/10 DIN B
- integrated LC-display mpu-LCD in the connecting head
- transmitters for PROFIBUS, HART, EX-zone
- fast response sensor tip 3mm and 4mm
- neck tube for temperature up to 250°C
- cables available in PTFE and other lengths

Order Code

Temperature sensor	Model head Ø55mm	Insertion length [mm]	Transmitter	Range	Electrical connection	Diameter sensor tip	Further options	
TFP-49		50, 100, 150, 250mm special length	without* mpu-4	-10...+40°C 0...50°C	PG* M12	3mm 4mm 6mm*	1/3B 1/10B	
TFP-... / ...2	2xPt100		mpu-4p (programmable) mpu-10 (Profibus PA) mpu-4ex (EX-zone) mpu-H (HART protocol) mpu-LCD (integ. display)	0...100°C 0...150°C 0...200°C			2xPG** 2xM12**	
Order example:		TFP-49 / 100 / mpu-4 / 0...150°C / M12 / 4mm / 1/3B					** only for model 2xPt100.	
Temperature sensor	Model head Ø19mm	Insertion length [mm]	Transmitter mpu-m	Range	Electrical connection	Diameter sensor tip	Further options	
TFP-169	M12-plug	50, 100, 150, 250mm special length	.m	-10...+40°C 0...50°C	M12* cable*	3mm 4mm 6mm*	1/3B 1/10B PTFE cable (TFP-189 only)	
TFP-189	fixed cable			0...100°C 0...150°C 0...200°C				
Order example:		TFP-169 / 100 .m / 0...150°C / 4mm						
Temperature sensor	Model without head	Insertion length [mm]	Transmitter	Range	Electrical connection	Diameter sensor tip	further Optionen	
TFP-06		50, 100, 150, 250mm special length	without*		cable*	3mm, 4mm 6mm*	1/3B, 1/10B IP68	
Order example:		TFP-06 / 100					*standard, no declaration needed.	



Specification Temperature Sensor

Process connection	hygienic	weld-in fitting e.g. EMK-25/76 or ESH-KM12/85
	standard	50, 100, 150, 250mm
Material	head	stainless steel 303 (1.4305)
	protection tube	316 L (1.4404)
Operating pressure	without ESH	max. 10bar
	with ESH	max. 50bar

Temperature range	ambient	-50...+80°C
	sensor tip	-50...+250°C
Sensing resistor	acc. ITS 90	1xPt100 class A
electrical connection	cable junction	M16x1,5 (PG)
	plug-in	M12-plug 303 (1.4305) 4pins
	fixed cable 2,5m option (>90°C)	LIYY 4x0,25mm ² PTFE 4x0,14mm ²
Protection class		IP69K
	TFP-06 (option)	IP68

Transmitter mpu-4, -4p, -10, -4ex, -HART

Temperature range	standard	-10...+40, 0...50°C 0...100 / 150 / 200°C
Accuracy		<±0,1% (full scale)
Temperature drift	zero, span	<0,01%/K (full scale)
Electrical connection	supply	8...35VDC
Output	analog	4-20mA
Temperature range	ambient	-40...+85°C
	storage	-40...+120°C
Humidity	without condensate	0...98%

Transmitter mpu-m

Temperature range	standard	-10...+40, 0...50°C 0...100 / 150 / 200°C
Accuracy		<±0,2% full scale
Temperature drift	zero, span	<0,02% full scale /K
Electrical connection	supply	12...36VDC
Output	analog	4-20mA
Temperature range	ambient	-50...+80°C

Accuracy Class Pt100

Tolerances of Pt100 acc. ITS 90

Pt100	class B	class A	class 1/3B	class 1/10B
0°C	±0,3K	±0,15K	±0,10K	±0,03K
100Ω	±0,12Ω	±0,06Ω	±0,04Ω	±0,01Ω
100°C	±0,8K	±0,35K	±0,27K	±0,08K
138,5Ω	±0,30Ω	±0,13Ω	±0,10Ω	±0,03Ω

Sensor tip diameter and response time

All temperature sensors are available with smaller sensor tips, to ensure a shorter response time. The below-mentioned times are according to a PT100 sensor in boiling water.

Sensor tip ø6mm with thermowell

validity: $t_{50} \leq 8,8s$
90%-time: $t_{90} \leq 24,5s$

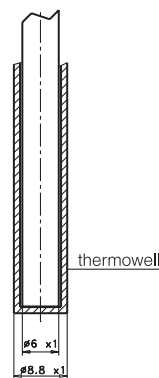

Sensor tip ø6mm

validity: $t_{50} \leq 3,0s$
90%-time: $t_{90} \leq 8,0s$

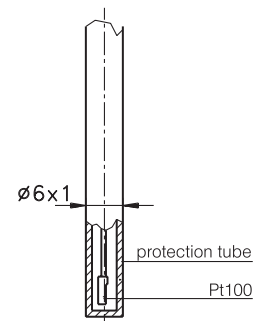

Option: mpu-LCD

integrated LC-Display in the connection head

Specifications: please look on separate product informations



temperatur sensor
with mpu-LCD
(view from top)

Features

- 4-digit display with green backlight
- temperature measurement in °C und °F
- easy range select by one button
- direct connection to the PLC
- lower costs for wiring because of 2-wire technology
- suitable for sensor monitoring

Sensor tip ø4mm

validity: $t_{50} \leq 2,4s$
90%-time: $t_{90} \leq 6,5s$

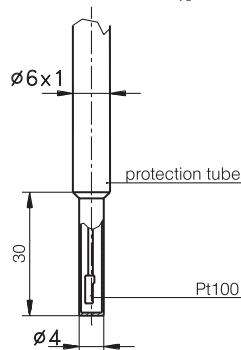

Sensor tip ø3mm

validity: $t_{50} \leq 0,5s$
90%-time: $t_{90} \leq 1,5s$

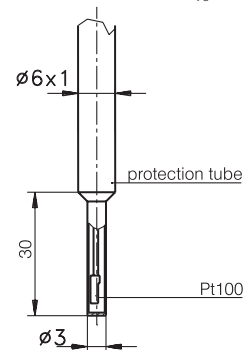

Accessories



Simulator hsg-3



Calibration Device htr

Drawings

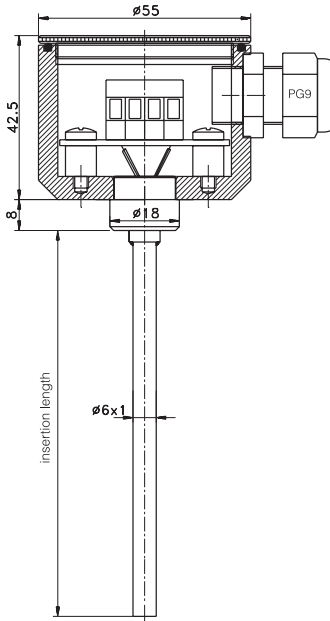

TFP-49/100

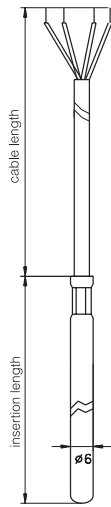

TFP-06/...

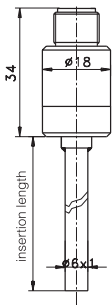

TFP-169/...

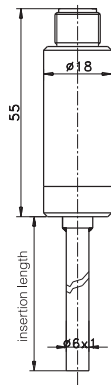

TFP-169/... .m

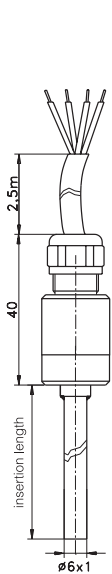

TFP-189/...

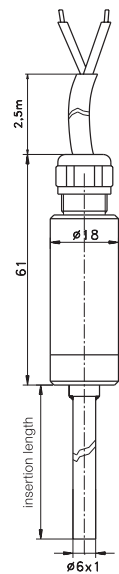

TFP-189/... .m

Electrical connections

without transmitter

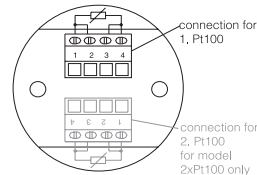

TFP-06 without transmitter
cable connection

wh ye br gn standard
rd rd wh wh PTFE

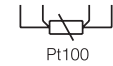

Pt100

with transmitter
mpu-4, -4p, -4ex, -10, -HART

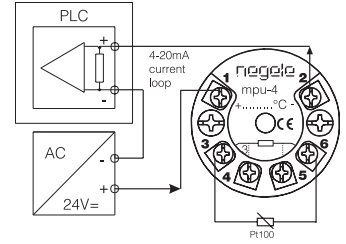

TFP-06 with option 2xPt100
cable connection

wh bn ye gn 1.Pt100
rd bu pk gy 2.Pt100

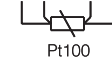

Pt100

without transmitter
M12 connection
(view from the top)

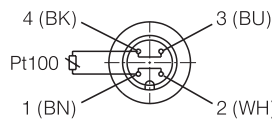

Pt100

with transmitter mpu-m
M12 connection
(view from the top)

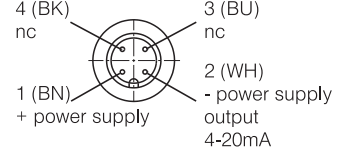

without transmitter
cable connection

wh ye bn gn standard
rd rd wh wh PTFE

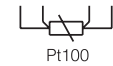

Pt100

option 2xPt100
cable connection

wh bn ye gn 1.Pt100
rd bu pk gy 2.Pt100

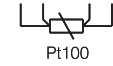

Pt100

with transmitter mpu-m
cable connection

bk: +24V Standard
rd: +24V PTFE

bu: -24V 4-20mA
wh -24V 4-20mA

cable PVC 2x0.5mm²
Option: PTFE-
cable (...200°C)

Process Connection

Important information: Use only Negele weld-in systems, to guarantee a safe function of the measurement point!

Drawings

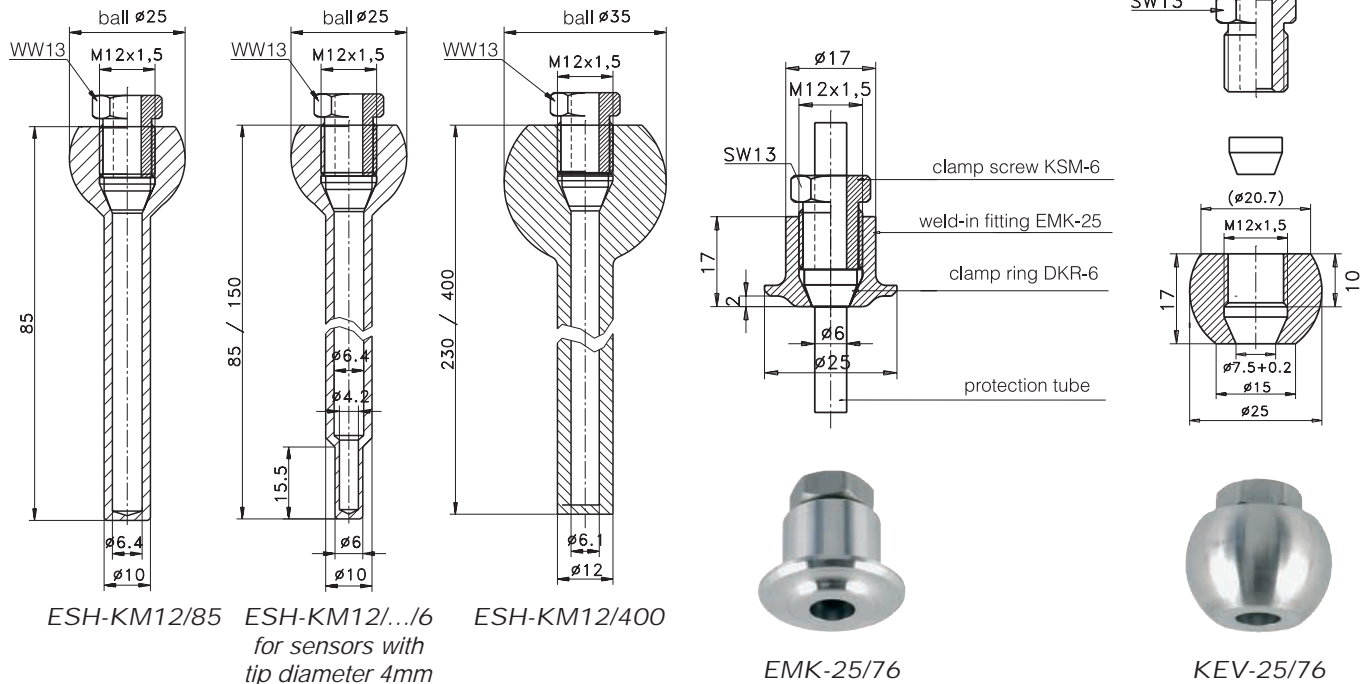

Specification ESH-KM12

Process connection	hygienic	thermowell
Insertion length in mm		85 (100mm sensor)
		150 (200mm sensor)
		230 (250mm sensor)
		400 (425mm sensor)
Material	thermowell	316 L (1.4404)
	option	3.1.B certificate
connection system		clamp ring PEEK
Operating pressure		max. 50bar

Clamp Connection with PEEK ring

The sensor is sealed by means of the conic sealing ring, made of heat-resistance PEEK material. Tightening the clamp screw the gap between sensor and sleeve will be closed totally and the sealing ring will be pressed against the sensor.

Order Designation

Process connection	Model	Insertion length	tip dia.**	certificate
ESH-KM12	thermowell*	85mm	6mm	3.1B
		150mm		
		230mm		
		400mm		
EMK-25/76	fitting with collar*			2.2
KEV-25/76	weld-in ball*			
* inclusive clamp screw and PEEK ring				
** for sensors with tip diameter 4mm				
Order example:	ESH - KM12 / 85 / 6 - 3.1B			

Specification EMK-25/76 and KEV-25/76

Process connection	hygienic	weld-in fitting
Material		316 L (1.4404)
	optional	3.1.B certificate
Connection system		clamp ring PEEK
		thread M12x1,5
Torque		max. 10Nm
Operating pressure		max. 10bar

Principle of the Connection

