

NovAseptic® Valve

Valve Body, Tank Outlet Valve 90°, Elbow 45° TC

Catalogue Number NU###/442-312

Valve Body, Tank Outlet Valve 90°, Elbow 45° TC Configuration

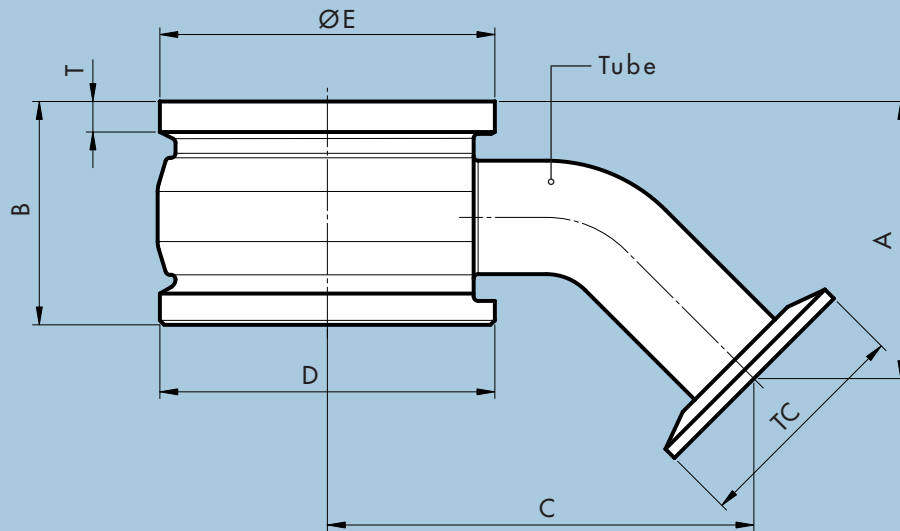

Nominal Dimensions in mm (in.)

A	B	C	D*	E	T	TC	US Tube ASTM® A269/270		
							NU###	Size	Tube
39.0 (1.535)	31.5 (1.240)	59.0 (2.323)	TR40x2	40.0 (1.575)	6.4 (0.252)	25.0 (0.984)	NU050	½"	12.7x1.65 (0.50x0.065)
55.0 (2.165)	39.0 (1.535)	98.0 (3.858)	TR55x2	55.0 (2.165)	7.2 (0.283)	25.0 (0.984)	NU075	¾"	19.1x1.65 (0.75x0.065)
62.0 (2.441)	50.0 (1.969)	96.0 (3.780)	TR75x2	75.0 (2.953)	6.8 (0.268)	50.5 (1.988)	NU100	1"	25.4x1.65 (1.0x0.065)
79.0 (3.110)	64.0 (2.520)	115.0 (4.528)	TR85x2	85.0 (3.346)	6.9 (0.272)	50.5 (1.988)	NU150	1½"	38.1x1.65 (1.5x0.065)
96.0 (3.780)	77.0 (3.031)	146.0 (5.748)	TR109x2	110.0 (4.331)	6.7 (0.264)	64.0 (2.520)	NU200	2"	50.8x1.65 (2.0x0.065)
134.0 (5.276)	115.0 (4.528)	207.0 (8.150)	TR146x2	150.0 (5.906)	10.0 (0.394)	91.0 (3.583)	NU300	3"	76.2x1.65 (3.0x0.065)

* Note: Non-standard thread, special thread to fit NovAseptic Actuators.

Specifications

Net Volume (valve cavity, diaphragm applied)

Valve Body	NU050	NU075	NU100	NU150	NU200	NU300
Volume ml	4	10	30	80	200	470

Net Weight (approximate)

Valve Body	NU050	NU075	NU100	NU150	NU200	NU300
Weight kg (lb)	0.2 (0.44)	0.5 (1.1)	0.9 (2.0)	1.5 (2.20)	2.8 (6.17)	7.5 (16.5)

Material

	Bar Stainless Steel in Compliance with		Tubing Stainless Steel in Compliance with	
Material Code	316L	EN 1.4435	TP316L	EN 1.4435
Technical Requirements	ASME® SA-479	EN 10272	ASTM® A269/270	EN 10217-7/ EN 10216-5

Specifications

Surface Roughness:	Internal surface (manually polished) $Ra \leq 0.5\mu\text{m}$ (20 μin) External surface $Ra \leq 1.6\mu\text{m}$ (63 μin)
Design Temperature, Valve Body:	-80 to 200 °C (-112 to 392 °F)
Design Pressure, Valve Body:	-1 to 10 bar(g) (-14.5 to 145 psi(g))
Note!	The applied diaphragm and actuator may have different design temperature and/or pressure limits. The weakest component in the assembled product determines the maximum design temperature and pressure limits.
Labeling:	Each Valve Body is individually labeled for full traceability and heat No. according to Millipore QA routines.
Packaging:	All open ends on the Valve Body are protected with plastic covers on delivery and packaged in a closed box.
Quality Control:	Millipore Quality Assurance System guarantees the control and traceability at all stages of the manufacturing.
In Compliance With:	The NovAseptic Valve is classified in Europe, for PED Directive 97/23/EC Category IV and approved by Notified Body. NovAseptic Valve is in compliance with ASME® BPE standard.
Options:	For non-standard NovAseptic Valve Body Options, please contact Millipore for further information.

To Place an Order or Receive Technical Assistance

For additional information call your nearest Millipore office or visit us at www.millipore.com.

In the U.S. and Canada, call toll-free 1-800-MILLIPORE (1-800-645-5476). In the U.S., Canada and Puerto Rico, fax orders to 1-800-MILLIFX (1-800-645-5439).

MILLIPORE

Millipore and NovAseptic are registered trademarks of Millipore Corporation or an affiliated company.

ASME is a registered trademark of the American Society of Mechanical Engineers.

ASTM is a registered trademark of the American Society for Testing and Materials.

Specifications subject to change without notice.

Lit. No. SP1139EN00 Rev. 1, 09/2006. Replaces DS-125

© 2006 Millipore Corporation. All rights reserved.